

d

# **A1** CABINET & GRANITE



## **TABLE OF CONTENTS**

<b>Introduction</b>	<b>3</b>
<b>Door Styles</b>	<b>4-5</b>
<b>Kitchen Samples</b>	<b>6-23</b>
<b>Specialty Cabinets</b>	<b>24</b>
<b>Product and Construction</b>	<b>25</b>
<b>Base Cabinet Specifications</b>	<b>26-27</b>
<b>Wall Cabinet Specifications</b>	<b>28-29</b>
<b>Wall + Wall Glass Cabinet Specifications</b>	<b>30</b>
<b>Wall Glass + Base Cabinet Specifications</b>	<b>31</b>
<b>Tall Cabinets Specifications</b>	<b>32</b>
<b>Tall + Vanity Cabinets Specifications</b>	<b>33</b>
<b>Vanity Cabinet + Molding + Decor Specs</b>	<b>34</b>
<b>Molding + Decor Specs</b>	<b>37-39</b>
<b>Kitchen Standard</b>	<b>40-41</b>
<b>Vanity Concept</b>	<b>42-43</b>
<b>Sinks</b>	<b>44</b>
<b>Pictures</b>	<b>45-46</b>
<b>Warranty</b>	<b>47</b>

## ***About Us***

Our goal at A1 Cabinet & Granite is to offer our customers high quality products at an affordable price. To accomplish this, we opened our own manufacturing facility to assure that the high quality demand of our current and future customers is satisfied. Our facilities are strictly managed and all of our products are evaluated thoroughly to ensure that our customers receive quality products at a competitive value.

The high level of customer service and dedication by our staff is confirmed by our repeat customers. We value the feedback and opinions of our customers greatly, that is why we continue to improve our products and expand our facility and warehouse in order to better serve customers. Our professional manufacturing team is paired with high-tech machinery to produce quality cabinets for our customer in a timely manner. Our support team located in Nebraska are committed to helping our current or potential customers with any questions or concerns. With questions regarding with kitchen designs to delivery dates, our staff is available to assist you.

A1 Cabinet & Granite provides semi-custom cabinets that are ready-to-assemble. We manufacture solid wood cabinets with the newest features such as soft close doors and drawers, dovetail drawers, thick plywood boxing, ball bearing drawer slides, and adjustable shelving.

Along with our cabinets, we also offer a wide variety of sinks and faucets to go with your cabinets. Our sinks and faucets are UPC certified and tested for quality. We provide stainless steel sinks that come in different layouts to match your personal taste along with different styles of faucet for your kitchen, vanity, or bar.

As we experience growth and success, we continue to believe that our customer satisfaction is our top priority. To achieve our continued success, we will work non-stop to improve our both our products and services.

## ***About Services***

We believe a product is only as good as the service that supports it. With our large inventory and variety of cabinet styles and sizes, customer orders can be fulfilled within days. We ship our cabinets on pallets throughout the US through freight carriers.



# DOOR STYLE

**A1-Espresso Maple**



**A2-Cherry Shaker**



**A3-Vanilla Shaker**



**A5-Chestnut Brown**



**A6-Classic White**



**A7-Honey Spice**



Note: Due to printing limitations, catalog pictures may not be true to the color. We strongly recommend you view an actual product sample for best color and wood grain representation.

**A8-Gray Shaker**



**A10-Flagstone Shaker**



**A11-Shaker White**







**A1- Espresso  
Maple**









## A2- CHERRY SHAKER







## A3-VANILLA SHAKER







## A5-CHESTNUT BROWN







Farm House Sink

## A6-CLASSIC WHITE









## A7-HONEY SPICE SHAKER







## A8-GRAY SHAKER







## **A10-FLAGSTONE SHAKER**



Clear Glass Insert





Base Microwave Cabinet



## A11-SHAKER WHITE



# SPECIALTY CABINETS



Base End Shelf



Farm House Sink



Base End Corner



Base Lazy Susan



Wall Microwave Cabinet



Base Waste Basket

A6 - A11



Base Wastebasket

A1-A3



# PRODUCT & CONSTRUCTION

## *Our Products*

All A1's cabinets are Ready-To-Assemble (RTA) and Semi-Customizable to our customer's specific needs. Our cabinets have all-wood, full overlay door, plywood construction (**Absolutely no particle board or MDF**), dovetail drawer boxes, heavy duty under-mounted soft-close drawer glides, hidden soft-close hinges and much more. We not only offer constructed standard sizes which are available in 3" increments, we also offer an extensive selection of accessories such as moldings, corbels, posts, valances, and decorative doors which enable us to offer consumers exceptional value with endless possibilities for their home.



- 1 Full Overlay Door, Solid Wood Center Panel
- 2 Soft Close, 6 Way Adjustable European Style Hidden Metal Hinges
- 3 3/4" or Full Depth Shelf Depending On Color, Edge Banded, Adjustable Plywood Shelf, Shelf Holder with Plastic Sucker & Thread for Wood/Glass Shelf
- 4 Dovetail Drawer, 1/2" Solid Wood Sides
- 5 Undermount Full Extension Soft Close Drawer Glides
- 6 Plywood Side Panel with Clear Coat / Natural Wood Interior Finish & Matching Finish Exterior
- 7 Metal Bracket Reinforcements for Base Cabinets Adhesive
- 8 Clear Door Bumper

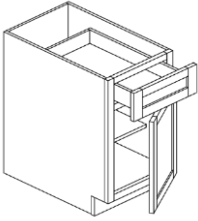
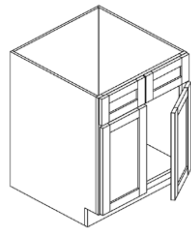
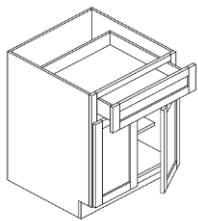
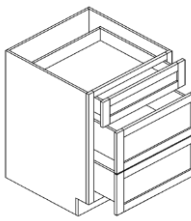
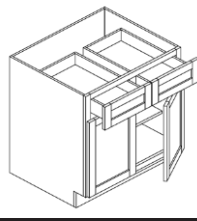
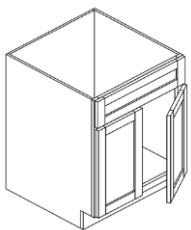
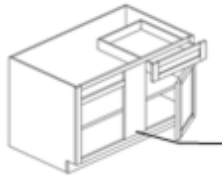

# BASE CABINETS

PRODUCT SPECS

	ITEM CODE	W"x H"x D"	AVAILABLE STYLES		ITEM CODE	W"x H"x D"	AVAILABLE STYLES	
<b>BASE CABINET - 1 DRAWER, 1 DOOR</b>				<b>SINK BASE CABINET</b>				
	B09	09 x 34.5 x 24	A1, A2, A3, A5, A6, A7, A8, A10, A11		SB33	33 x 34.5 x 24	A5, A6, A7, A8, A10, A11	
	B12	12 x 34.5 x 24	A1, A2, A3, A5, A6, A7, A8, A10, A11		SB36	36 x 34.5 x 24	A5, A6, A7, A8, A10, A11	
	B15	15 x 34.5 x 24	A1, A2, A3, A5, A6, A7, A8, A10, A11		SB42	42 x 34.5 x 24	A3, A5, A6, A7, A8, A10, A11	
	B18	18 x 34.5 x 24	A1, A2, A3, A5, A6, A7, A8, A10, A11		2 Dummy Drawers, 2 Doors, No Shelf <b>Note: Back Panel Not Cut for Plumbing</b>			
	B21	21 x 34.5 x 24	A1, A2, A3, A5, A6, A7, A8, A10, A11					
	1 Drawer, 1 Door, 1 Adj. Shelf, 1 Set of Glides A1-A3 ¾ DEPTH SHELVES A5-A11 FULL DEPTH SHELVES							
<b>BASE CABINET - 1 DRAWER, 2 DOORS</b>				<b>BASE DRAWER CABINET - 3 DRAWERS</b>				
	B24	24 x 34.5 x 24	A1, A2, A3, A5, A6, A7, A8, A10, A11		DB12-3	12 x 34.5 x 24	A1, A2, A3, A5, A6, A7, A8, A10, A11	
	B27	27 x 34.5 x 24	A1, A2, A3, A5, A6, A7, A8, A10, A11		DB15-3	15 x 34.5 x 24	A1, A2, A3, A5, A6, A7, A8, A10, A11	
	B30	30 x 34.5 x 24	A1, A2, A3, A5, A6, A7, A8, A10, A11		DB18-3	18 x 34.5 x 24	A1, A2, A3, A5, A6, A7, A8, A10, A11	
	B33	33 x 34.5 x 24	A1, A2		DB21-3	21 x 34.5 x 24	A1, A2, A3, A5, A6, A7, A8, A10, A11	
	B36	36 x 34.5 x 24	A1, A2		DB24-3	24 x 34.5 x 24	A1, A2, A3, A5, A6, A7, A8, A10, A11	
	B39	39 x 34.5 x 24	A1, A2		DB27-3	27 x 34.5 x 24	A1, A2, A3, A5, A6, A7, A8, A10, A11	
	B42	42 x 34.5 x 24	A1, A2		DB30-3	30 x 34.5 x 24	A1, A2, A3, A5, A6, A7, A8, A10, A11	
	1 Drawer, 2 Doors, 1 Adj. Shelf, 1 Set of Glides A1-A3 ¾ DEPTH SHELVES A5-A11 FULL DEPTH SHELVES				DB33-3	33 x 34.5 x 24	A1, A2, A3, A5, A6, A7, A8, A10, A11	
<b>BASE CABINET - 2 DRAWERS, 2 DOORS</b>					DB36-3	36 x 34.5 x 24	A1, A2, A3, A5, A6, A7, A8, A10, A11	
	B33	33 x 34.5 x 24	A3, A5, A6, A7, A8, A10, A11		1 Small Drawer, 2 Large Drawers, 3 Sets of Glides			
	B36	36 x 34.5 x 24	A3, A5, A6, A7, A8, A10, A11					
	B42	42 x 34.5 x 24	A3, A5, A6, A7, A8, A10, A11					
	2 Drawers, 2 Doors, 1 Adj. Shelf, 2 Sets of Glides A1-A3 ¾ DEPTH SHELVES A5-A11 FULL DEPTH SHELVES							
<b>SINK BASE CABINET</b>				<b>BASE BLIND CORNER</b>				
	SB30	30 x 34.5 x 24	A1, A2, A3, A5, A6, A7, A8, A10, A11		BBC36	36 x 34.5 x 24	A1, A2, A3, A5, A6, A7, A8, A10, A11	
	SB33	33 x 34.5 x 24	A1, A2, A3		BBC42	42 x 34.5 x 24	A1, A2, A3, A5, A6, A7, A8, A10, A11	
	SB36	36 x 34.5 x 24	A1, A2, A3		1 Drawer, 1 Door, 1 Adj. Shelf, 1 Set of Glides, BBC42: 9" Filler <b>Note: Min. 3" Space Between Wall and Cabinet During Installation, Specify Left / Right When Ordering Assembled</b>			
	SB42	42 x 34.5 x 24	A1, A2					
	1 Dummy Drawer, 2 Doors, No Shelf <b>Note: Back Panel Not Cut for Plumbing</b>							

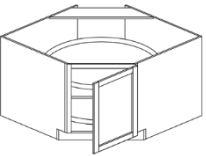
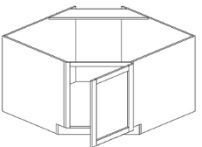
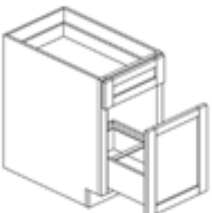
Note: Specifications are subject to change without notice. Our style and product availability may vary slightly from those shown in this catalog.

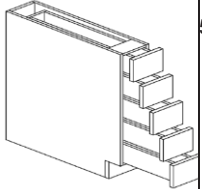
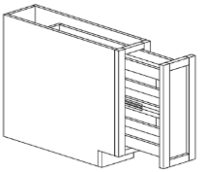
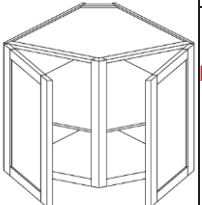
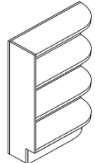
	ITEM CODE	W"x H"x D"	AVAILABLE STYLES
<b>BASE LAZY SUSAN</b>			
	BLS33	33 x 34.5 x 24	A1, A2, A3, A5, A6, A7, A8, A10, A11
	BLS36	36 x 34.5 x 24	A1, A2, A3, A5, A6, A7, A8, A10, A11
<b>BASE DIAGONAL CORNER</b>			
	BDC36	36 x 34.5 x 24	A1, A2, A3, A5, A6, A7, A8, A10, A11
	<p>A1-A3 Do Not Come Standard with Spinners, Must Be Specified When Ordered</p> <p>1 Door, 2 Wooden Round Trays</p> <p>Note: Door Dimension: 14 3/4" W x 29 1/4" H</p>		
<b>CORNER SINK BASE</b>			
	NCSB36	36 x 34.5 x 24	A1, A2, A3, A5, A6, A7, A8, A10, A11
	NCSB42	42 x 34.5 x 24	A1, A2, A3, A5, A6, A7, A8, A10, A11
	<p>NCSB 36-1 Door, No Shelf, No Tray</p> <p><b>NCSB42 -2 DOORS</b></p> <p>Note: Door Dimension: 14 3/4" W x 29 1/4" H, Back Panel Not Cut for Plumbing</p>		
<b>BASE WASTEBASKET CABINET</b>			
	BWBK18-2	18 x 34.5 x 24	A5, A6, A7, A8, A10, A11
	BWBK18	18 x 34.5 x 24	A1, A2, A3
	<p>Waste Basket(s) Sold Separately</p> <p>BWBK18-2, Two Wastebaskets</p> <p>BWBK18, One Wastebasket</p> <p>1 Drawer, 1 Door, 2 Bins Cut Out, 2 Sets Of Glides Plastic Bin Available</p>		

	ITEM CODE	W"x H"x D"	AVAILABLE STYLES
<b>BASE SPICE DRAWER CABINET</b>			
	BSD06	06 x 34.5 x 24	A1, A2, A3, A5, A6, A7, A8, A10, A11
	5 Drawers, No Glides, No Soft Close Drawers		
<b>BASE SPICE PULL OUT</b>			
	BSR09	09 x 34.5 x 24	A1, A2, A3, A5, A6, A7, A8, A10, A11
	<p>1 Door, 3 Shelves, 1 Set of Glides, Soft Close</p> <p>Note: Door Dimension: 8 3/4" W x 29 1/4" H</p>		
<b>BASE END CORNER CABINET</b>			
	BEC24	24 x 34.5 x 24	A1, A2, A3, A5, A6, A7, A8, A10, A11
	<p>2 Doors, 1 Adj. Shelf</p> <p>Note: Door Dimension: 17 3/4" W x 29 1/4" H</p>		
<b>BASE END OPEN SHELF (L/R)</b>			
	BES09 L/R	09 x 34.5 x 24	A5, A6, A7, A8, A10, A11
	BOES L/R	09 x 34.5 x 24	A1, A2, A3
	<p>3 Fixed Shelves, Matching Color Finish</p> <p>Note: Specify Left/Right When Ordering Assembled</p>		
	<b>BOES09</b>		

Note: Specifications are subject to change without notice. Our style and product availability may vary slightly from those shown in this catalog.

# WALL CABINETS

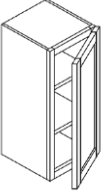
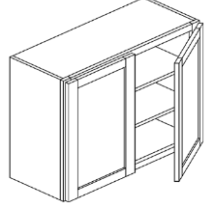
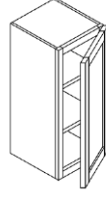
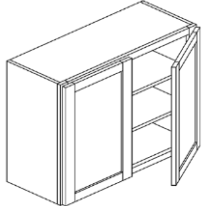
	ITEM CODE	W"x H"x D"	AVAILABLE STYLES
<b>WALL CABINET - 30" H</b>			
	W0930	09 x 30 x 12	A1, A2, A3, A5, A6, A7, A8, A10, A11
	W1230	12 x 30 x 12	A1, A2, A3, A5, A6, A7, A8, A10, A11
	W1530	15 x 30 x 12	A1, A2, A3, A5, A6, A7, A8, A10, A11
	W1830	18 x 30 x 12	A1, A2, A3, A5, A6, A7, A8, A10, A11
	W2130	21 x 30 x 12	A1, A2, A3, A5, A6, A7, A8, A10, A11
	1 Door, 2 Adj. Shelves		
<b>WALL CABINET - 30" H</b>			
	W2430	24 x 30 x 12	A1, A2, A3, A5, A6, A7, A8, A10, A11
	W2730	27 x 30 x 12	A1, A2, A3, A5, A6, A7, A8, A10, A11
	W3030	30 x 30 x 12	A1, A2, A3, A5, A6, A7, A8, A10, A11
	W3330	33 x 30 x 12	A1, A2, A3, A5, A6, A7, A8, A10, A11
	W3630	36 x 30 x 12	A1, A2, A3, A5, A6, A7, A8, A10, A11
	W3930	39 x 30 x 12	A1, A2, A3, A5, A6, A7, A8, A10, A11
	W4230	42 x 30 x 12	A1, A2, A3, A5, A6, A7, A8, A10, A11
2 Doors, 2 Adj. Shelves			
<b>WALL CABINET - 36" H</b>			
	W0936	09 x 36 x 12	A1, A2, A3, A5, A6, A7, A8, A10, A11
	W1236	12 x 36 x 12	A1, A2, A3, A5, A6, A7, A8, A10, A11
	W1536	15 x 36 x 12	A1, A2, A3, A5, A6, A7, A8, A10, A11
	W1836	18 x 36 x 12	A1, A2, A3, A5, A6, A7, A8, A10, A11
	W2136	21 x 36 x 12	A1, A2, A3, A5, A6, A7, A8, A10, A11
	1 Door, 2 Adj. Shelves		
<b>WALL CABINET - 36" H</b>			
	W2436	24 x 36 x 12	A1, A2, A3, A5, A6, A7, A8, A10, A11
	W2736	27 x 36 x 12	A1, A2, A3, A5, A6, A7, A8, A10, A11
	W3036	30 x 36 x 12	A1, A2, A3, A5, A6, A7, A8, A10, A11
	W3336	33 x 36 x 12	A1, A2, A3, A5, A6, A7, A8, A10, A11
	W3636	36 x 36 x 12	A1, A2, A3, A5, A6, A7, A8, A10, A11
	W3936	39 x 36 x 12	A1, A2, A3, A5, A6, A7, A8, A10, A11
	W4236	42 x 36 x 12	A1, A2, A3, A5, A6, A7, A8, A10, A11
2 Doors, 2 Adj. Shelves			

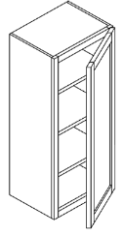
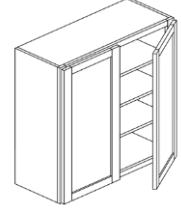
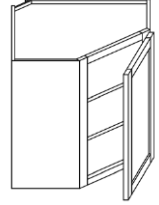
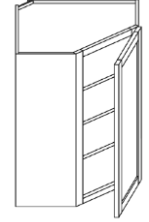
	ITEM CODE	W"x H"x D"	AVAILABLE STYLES
<b>WALL CABINET - 42" H</b>			
	W0942	09 x 42 x 12	A1, A2, A3, A5, A6, A7, A8, A10, A11
	W1242	12 x 42 x 12	A1, A2, A3, A5, A6, A7, A8, A10, A11
	W1542	15 x 42 x 12	A1, A2, A3, A5, A6, A7, A8, A10, A11
	W1842	18 x 42 x 12	A1, A2, A3, A5, A6, A7, A8, A10, A11
	W2142	21 x 42 x 12	A1, A2, A3, A5, A6, A7, A8, A10, A11
	1 Door, 3 Adj. Shelves		
<b>WALL CABINET - 42" H</b>			
	W2442	24 x 42 x 12	A1, A2, A3, A5, A6, A7, A8, A10, A11
	W2742	27 x 42 x 12	A1, A2, A3, A5, A6, A7, A8, A10, A11
	W3042	30 x 42 x 12	A1, A2, A3, A5, A6, A7, A8, A10, A11
	W3342	33 x 42 x 12	A1, A2, A3, A5, A6, A7, A8, A10, A11
	W3642	36 x 42 x 12	A1, A2, A3, A5, A6, A7, A8, A10, A11
	W3942	39 x 42 x 12	A1, A2, A3, A5, A6, A7, A8, A10, A11
	W4242	42 x 42 x 12	A1, A2, A3, A5, A6, A7, A8, A10, A11
	2 Doors, 3 Adj. Shelves		
<b>WALL DIAGONAL CORNER CABINET - 30" &amp; 36" H</b>			
	WDC2430	24 x 30 x 12	A1, A2, A3, A5, A6, A7, A8, A10, A11
	WDC2436	24 x 36 x 12	A1, A2, A3, A5, A6, A7, A8, A10, A11
	WDC273615	27 x 36 x 15	A1, A2, A3, A5, A6, A7, A8, A10, A11
	1 Door: 14 3/4" W, 2 Adj. Shelves <b>Note: 24" Corner Cabinet: 12" Deep, 27" Corner Cabinet: 15" Deep</b>		
<b>WALL DIAGONAL CORNER CABINET - 42" H</b>			
	WDC2442	24 x 42 x 12	A1, A2, A3, A5, A6, A7, A8, A10, A11
	WDC274215	27 x 42 x 15	A1, A2, A3, A5, A6, A7, A8, A10, A11
	1 Door: 14 3/4" W, 3 Adj. Shelves <b>Note: 24" Corner Cabinet: 12" Deep, 27" Corner Cabinet: 15" Deep</b>		

Note: Specifications are subject to change without notice. Our style and product availability may vary slightly from those shown in this catalog.

ITEM CODE	W"x H"x D"	AVAILABLE STYLES
-----------	------------	------------------

**WALL BRIDGE CABINET - NO SHELF - 30" W - 36" W**

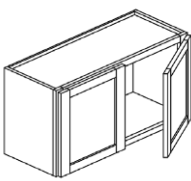
	W3012	30 x 12 x 12	A1, A2, A3, A5, A6, A7, A8, A10, A11
	W3015	30 x 15 x 12	A1, A2, A3, A5, A6, A7, A8, A10, A11
	W3018	30 x 18 x 12	A1, A2, A3, A5, A6, A7, A8, A10, A11
	W3021	30 x 21 x 12	A1, A2, A3, A5, A6, A7, A8, A10, A11
	W3312	33 x 12 x 12	A1, A2, A3, A5, A6, A7, A8, A10, A11
	W3318	33 x 18 x 12	A1, A2, A3, A5, A6, A7, A8, A10, A11
	W3612	36 x 12 x 12	A1, A2, A3, A5, A6, A7, A8, A10, A11
	W3615	36 x 15 x 12	A1, A2, A3, A5, A6, A7, A8, A10, A11
	W3618	36 x 18 x 12	A1, A2, A3, A5, A6, A7, A8, A10, A11
	W3621	36 x 21 x 12	A1, A2, A3, A5, A6, A7, A8, A10, A11
2 Doors, No Shelf			

**WALL BRIDGE CABINET - 1 SHELF**

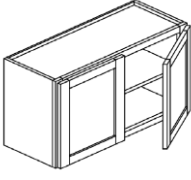
	W3024	30 x 24 x 12	A1, A2, A3, A5, A6, A7, A8, A10, A11
	W3324	33 x 24 x 12	A1, A2, A3, A5, A6, A7, A8, A10, A11
	W3624	36 x 24 x 12	A1, A2, A3, A5, A6, A7, A8, A10, A11
2 Doors, 1 Shelf			

**WALL REFRIGERATOR CABINET - NO SHELF - 33" W**

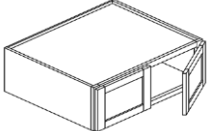
	W331227	33 x 12 x 27	A1, A2, A3, A5, A6, A7, A8, A10, A11
	W331527	33 x 15 x 27	A1, A2, A3, A5, A6, A7, A8, A10, A11
	W331827	33 x 18 x 27	A1, A2, A3, A5, A6, A7, A8, A10, A11
	W332127	33 x 21 x 27	A2, A5, A6, A7, A8, A10, A11
27" Deep, 2 Doors, No Shelf			

ITEM CODE	W"x H"x D"	AVAILABLE STYLES
-----------	------------	------------------

**WALL REFRIGERATOR CABINET - NO SHELF - 36" W**

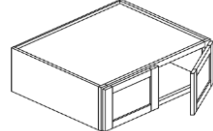
	W361227	36 x 12 x 27	A1, A2, A3, A5, A6, A7, A8, A10, A11
	W361527	36 x 15 x 27	A1, A2, A3, A5, A6, A7, A8, A10, A11
	W361827	36 x 18 x 27	A1, A2, A3, A5, A6, A7, A8, A10, A11
	W362127	36 x 21 x 27	A1, A2, A3, A5, A6, A7, A8, A10, A11
27" Deep, 2 Doors, No Shelf			

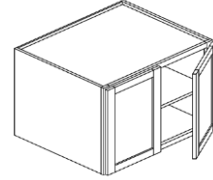

**WALL REFRIGERATOR CABINET - 1 SHELF**

	W332427	33 x 24 x 27	A1, A2, A3, A5, A6, A7, A8, A10, A11
	W362427	36 x 24 x 27	A1, A2, A3, A5, A6, A7, A8, A10, A11
27" Deep, 2 Doors, 1 Adj. Shelf			

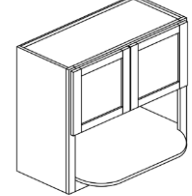
**WALL MICROWAVE CABINET - OPEN SHELF**

	WM273012	27 x 30 x 12	A1, A2, A3, A5, A6, A7, A8, A10, A11
	WM273612	27 x 36 x 12	A1, A2, A3, A5, A6, A7, A8, A10, A11
	WM274212	27 x 42 x 12	A1, A2, A3, A5, A6, A7, A8, A10, A11
20" Shelf Depth 12" Deep, 2 Doors, 1 Open Shelf			
<b>Note: Cabinet Opening: 23 7/8" W x 15 3/4" H, Matching Color Finish Interiors</b>			

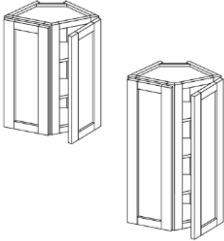
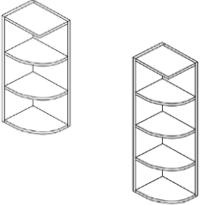
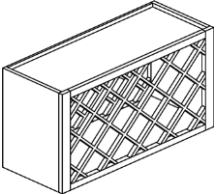
Note: Specifications are subject to change without notice. Our style and product availability may vary slightly from those shown in this catalog.

WALL CABINETS			
	ITEM CODE	W"x H"x D"	AVAILABLE STYLES
<b>WALL END CORNER</b>			
	WEC1230	12 x 30 x 12	A1, A2, A3, A5, A6, A7, A8, A10, A11
	WEC1236	12 x 36 x 12	A1, A2, A3, A5, A6, A7, A8, A10, A11
	WEC1242	12 x 42 x 12	A1, A2, A3, A5, A6, A7, A8, A10, A11
	2 Doors: 8 3/4" W Note: 2 Adj. Shelves: 30" H & 36" H, 3 Adj. Shelves: 42" H		
<b>WALL END OPEN SHELF (L/R)</b>			
	WES0930 L/R	09 x 30 x 12	A1, A2, A3, A5, A6, A7, A8, A10, A11
	WES0936 L/R	09 x 36 x 12	A1, A2, A3, A5, A6, A7, A8, A10, A11
	WES0942 L/R	09 x 42 x 12	A1, A2, A3, A5, A6, A7, A8, A10, A11
	Top Shelf: Square, Matching Color Finish Note: 2 Fixed Shelves: 30" & 36" H, 3 Fixed Shelves: 42" H, Specify Left / Right When Ordering Assembled		
<b>WALL WINE RACK</b>			
	30WR	30 x 15 x 12	A1, A2, A3, A5, A6, A7, A8, A10, A11
	36WR	36 x 15 x 12	A1, A2, A3, A5, A6, A7, A8, A10, A11
	WRC3018	30 x 18 x 12	A1, A2, A3
	WRC3618	36 x 18 x 12	A1, A2, A3
	30WR: 14 Compartments, 36WR: 16 Compartments Note: Matching Color Finish		
<b>WALL GLASS RACK</b>			
	30GR	30 x 1.5 x 12	A5, A6, A7, A8, A10, A11
	36GR	36 x 1.5 x 12	A5, A6, A7, A8, A10, A11
	SGH3012	30 x 1.75 x 12	A1, A2, A3
	SGH3612	36 x 1.75 x 12	A1, A2, A3
	All Wood Note: Matching Color Finish		

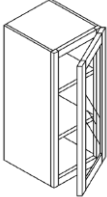
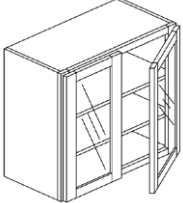
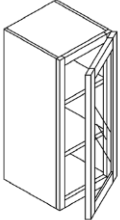
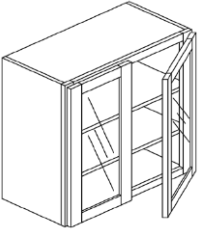
WALL GLASS CABINETS			
	ITEM CODE	W"x H"x D"	AVAILABLE STYLES
<b>WALL GLASS CABINET - 30" H</b>			
	WMD1530	15 x 30 x 12	A1, A2, A3, A5, A6, A7, A8, A10, A11
	WMD1830	18 x 30 x 12	A1, A2, A3, A5, A6, A7, A8, A10, A11
	WMD2130	21 x 30 x 12	A1, A2, A3, A5, A6, A7, A8, A10, A11
	1 Door: Center Panel Cutout, 2 Adj. Matching Color Shelves, Matching Color Interior Note: Glass Inserts & Glass Shelves Sold Separately		
<b>WALL GLASS CABINET - 30" H</b>			
	WMD2430	24 x 30 x 12	A1, A2, A3, A5, A6, A7, A8, A10, A11
	WMD2730	27 x 30 x 12	A1, A2, A3, A5, A6, A7, A8, A10, A11
	WMD3030	30 x 30 x 12	A1, A2, A3, A5, A6, A7, A8, A10, A11
	WMD3330	33 x 30 x 12	A1, A2, A3, A5, A6, A7, A8, A10, A11
	WMD3630		A1, A2, A3, A5, A6, A7, A8, A10, A11
2 Doors: Center Panel Cutout, 2 Adj. Matching Color Shelves, Matching Color Interior Note: Glass Inserts & Glass Shelves Sold Separately			
<b>WALL GLASS CABINET - 36" H</b>			
	WMD1536	15 x 36 x 12	A1, A2, A3, A5, A6, A7, A8, A10, A11
	WMD1836	18 x 36 x 12	A1, A2, A3, A5, A6, A7, A8, A10, A11
	WMD2136	21 x 36 x 12	A1, A2, A3, A5, A6, A7, A8, A10, A11
	1 Door: Center Panel Cutout, 2 Adj. Matching Color Shelves, Matching Color Interior Note: Glass Inserts & Glass Shelves Sold Separately		
<b>WALL GLASS CABINET - 36" H</b>			
	WMD2436	24 x 36 x 12	A1, A2, A3, A5, A6, A7, A8, A10, A11
	WMD2736	27 x 36 x 12	A1, A2, A3, A5, A6, A7, A8, A10, A11
	WMD3036	30 x 36 x 12	A1, A2, A3, A5, A6, A7, A8, A10, A11
	WMD3336	33 x 36 x 12	A1, A2, A3, A5, A6, A7, A8, A10, A11
	WMD3636	36 x 36 x 12	A1, A2, A3, A5, A6, A7, A8, A10, A11
2 Doors: Center Panel Cutout, 2 Adj. Matching Color Shelves, Matching Color Interior Note: Glass Inserts & Glass Shelves Sold Separately			

Note: Specifications are subject to change without notice. Our style and product availability may vary slightly from those shown in this catalog.

## WALL GLASS CABINETS

	ITEM CODE	W"x H"x D"	AVAILABLE STYLES
--	-----------	------------	------------------

### WALL GLASS CABINET - 42" H

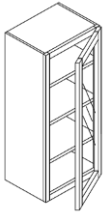

WMD1542	15 x 42 x 12	A1, A2, A3, A5, A6, A7, A8, A10, A11
WMD1842	18 x 42 x 12	A1, A2, A3, A5, A6, A7, A8, A10, A11
WMD2142	21 x 42 x 12	A1, A2, A3, A5, A6, A7, A8, A10, A11

1 Door: Center Panel Cutout, 3 Adj. Matching Color Shelves, Matching Color Interior

**Note: Glass Inserts & Glass Shelves Sold Separately**

### WALL GLASS CABINET - 42" H

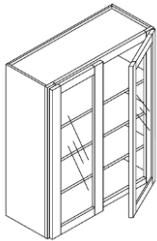

WMD2442	24 x 42 x 12	A1, A2, A3, A5, A6, A7, A8, A10, A11
WMD2742	27 x 42 x 12	A1, A2, A3, A5, A6, A7, A8, A10, A11
WMD3042	30 x 42 x 12	A1, A2, A3, A5, A6, A7, A8, A10, A11
WMD3342	33 x 42 x 12	A1, A2, A3, A5, A6, A7, A8, A10, A11
WMD3642	36 x 42 x 12	A1, A2, A3, A5, A6, A7, A8, A10, A11

1 Door: Center Panel Cutout, 3 Adj. Matching Color Shelves, Matching Color Interior

**Note: Glass Inserts & Glass Shelves Sold Separately**

### WALL DIAGONAL CORNER GLASS CABINET - 30" & 36" H

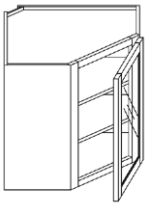

WDCMD2430	24 x 30 x 12	A1, A2, A3, A5, A6, A7, A8, A10, A11
WDCMD2436	24 x 36 x 12	A1, A2, A3, A5, A6, A7, A8, A10, A11
WDCMD2736 15	27 x 36 x 15	A1, A2, A3, A5, A6, A7, A8, A10, A11

1 Door: Center Panel Cutout, 2 Adj. Matching Color Shelves, Matching Color Interior

**Note: Glass Inserts & Glass Shelves Sold Separately, 24" Corner Cabinet: 12" Deep, 27" Corner Cabinet: 15" Deep**

### WALL DIAGONAL CORNER GLASS CABINET - 42" H

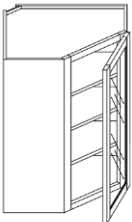

WDCMD2442	24 x 42 x 12	A1, A2, A3, A5, A6, A7, A8, A10, A11
WDCMD2742 15	27 x 42 x 15	A1, A2, A3, A5, A6, A7, A8, A10, A11

1 Door: Center Panel Cutout, 3 Adj. Matching Color Shelves, Matching Color Interior

**Note: Glass Inserts & Glass Shelves Sold Separately, 24" Corner Cabinet: 12" Deep, 27" Corner Cabinet: 15" Deep**

## BASE CABINETS

	ITEM CODE	W"x H"x D"	AVAILABLE STYLES
--	-----------	------------	------------------

### BASE APRON FRONT SINK CABINET

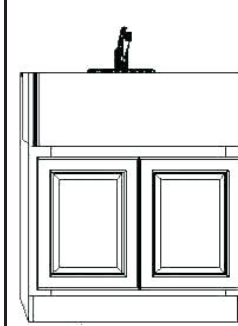

APSB36	36 x 34.5 x 24	A1, A2, A3, A5, A6, A7, A8, A10, A11
--------	----------------	--------------------------------------

33"x9" Opening

### BASE MICROWAVE CABINET

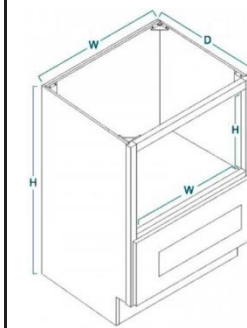

BMW30	30 x 34.5 x 24	A1, A2, A3, A5, A6, A7, A8, A10, A11
-------	----------------	--------------------------------------

26 7/8" \* 15 3/4" Opening

**Note: Specifications are subject to change without notice. Our style and product availability may vary slightly from those shown in this catalog.**

	ITEM CODE	W"x H"x D"	AVAILABLE STYLES
--	-----------	------------	------------------

TALL PANTRY CABINET - WITH SHELVES - 27" DEEP			
	PC188427	18 x 84 x 27	A1, A2, A3, A5, A6, A7, A8, A10, A11
	PC189027	18 x 90 x 27	A1, A2, A3, A5, A6, A7, A8, A10, A11
	PC189627	18 x 96 x 27	A1, A2, A3, A5, A6, A7, A8, A10, A11
	27" Deep, 2 Doors, 5 Adjustable Shelves: 84" & 90" H, 6 Shelves: 96" H <b>Note: Roll Out Trays are sold separately</b>		

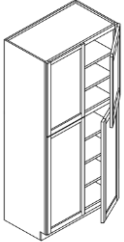
TALL PANTRY CABINET - WITH SHELVES - 27" DEEP			
	PC248427	24 x 84 x 27	A1, A2, A3, A5, A6, A7, A8, A10, A11
	PC249027	24 x 90 x 27	A1, A2, A3, A5, A6, A7, A8, A10, A11
	PC249627	24 x 96 x 27	A1, A2, A3, A5, A6, A7, A8, A10, A11
	PC308427	30 x 84 x 27	A1, A2, A3, A5, A6, A7, A8, A10, A11
	PC309027	30 x 90 x 27	A1, A2, A3, A5, A6, A7, A8, A10, A11
	PC309627	30 x 96 x 27	A1, A2, A3, A5, A6, A7, A8, A10, A11
27" Deep, 4 Doors, 5 Adjustable Shelves: 84" & 90" H, 6 Shelves: 96" H <b>Note: Roll Out Trays are sold separately</b>			

Note: Specifications are subject to change without notice. Our style and product availability may vary slightly from those shown in this catalog.

## TALL CABINETS

	ITEM CODE	W"x H"x D"	AVAILABLE STYLES
--	-----------	------------	------------------

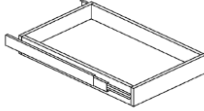
ROLL OUT TRAY - CLEAR COAT FINISH			
	ROT15	10 7/8 x 4 x 22	A1, A2, A3, A5, A6, A7, A8, A10, A11
	ROT18	13 7/8 x 4 x 22	A1, A2, A3, A5, A6, A7, A8, A10, A11
	ROT21	16 7/8 x 4 x 22	A1, A2, A3, A5, A6, A7, A8, A10, A11
	ROT24	19 7/8 x 4 x 22	A1, A2, A3, A5, A6, A7, A8, A10, A11
	ROT27	22 7/8 x 4 x 22	A1, A2, A3, A5, A6, A7, A8, A10, A11
	ROT30	25 7/8 x 4 x 22	A1, A2, A3, A5, A6, A7, A8, A10, A11
	ROT33	28 7/8 x 4 x 22	A1, A2, A3, A5, A6, A7, A8, A10, A11
	ROT36	31 7/8 x 4 x 22	A1, A2, A3, A5, A6, A7, A8, A10, A11
Clear Coat Finish, 4" Height, 22" Deep, Soft Close  <b>If used in Pantry, Deeper Glides required</b>			

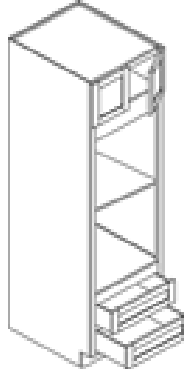
SINGLE OVEN CABINET 27" DEEP			
	SOC308427	30 x 84 x 27	A5, A6, A7, A8, A10, A11
	SOC309027	30 x 90 x 27	A5, A6, A7, A8, A10, A11
	SOC309627	30 x 96 x 27	A5, A6, A7, A8, A10, A11
<b>Call For Availability</b> 2 Doors, 2 Sets of Glides, 1 Adj. Shelf, A5-11 :2 Drawers: T: 7" H T: 9 1/4" H, B: 1-9/16" H <b>Opening: 26 7/8" W x 38 3/8" H</b> <b>Note: Matching Color Finish</b>			



# TALL CABINETS

ITEM CODE	W"x H"x D"	AVAILABLE STYLES
-----------	------------	------------------

## DOUBLE OVEN CABINET 27" DEEP

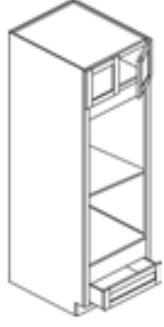
	DOC338427	33 x 84 x 27	A1, A2, A3, A5, A6, A7, A8, A10, A11
	DOC339027	33 x 90 x 27	A1, A2, A3, A5, A6, A7, A8, A10, A11
	DOC339627	33 x 96 x 27	A1, A2, A3, A5, A6, A7, A8, A10, A11
	2 Doors, 1 Set of Glides, 1 Adj. Shelf, 1 Drawer: 10 7/8" H, Stile: T: 9 1/4" H, B: 5 3/8" H <b>33" Oven Opening: 28 3/4" W x 43" H</b> Note: Matching Color Finish		

## VANITY BASE CABINET

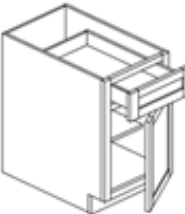
	VB12	12 x 34.5 x 21	A1, A2, A3, A5, A6, A7, A8, A10, A11
	VB15	15 x 34.5 x 21	A1, A2, A3, A5, A6, A7, A8, A10, A11
	VB18	18 x 34.5 x 21	A1, A2, A3, A5, A6, A7, A8, A10, A11
	VB21	21 x 34.5 x 21	A1, A2, A3, A5, A6, A7, A8, A10, A11
	1 Drawer, 1 Door, 1 Adj. Shelf, 1 Set of Glides		

## VANITY DRAWER BASE CABINET

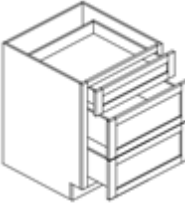
	VBD12-3	12 x 34.5 x 21	A1, A2, A3, A5, A6, A7, A8, A10, A11
	VBD15-3	15 x 34.5 x 21	A1, A2, A3, A5, A6, A7, A8, A10, A11
	VBD18-3	18 x 34.5 x 21	A1, A2, A3, A5, A6, A7, A8, A10, A11
	VBD21-3	21 x 34.5 x 21	A1, A2, A3, A5, A6, A7, A8, A10, A11
	VBD24-3	24 x 34.5 x 21	A1, A2, A3, A5, A6, A7, A8, A10, A11
	1 Small Drawer, 2 Large Drawers, 3 Sets of Glides		

# VANITY CABINETS

ITEM CODE	W"x H"x D"	AVAILABLE STYLES
-----------	------------	------------------

## VANITY SINK BASE CABINET

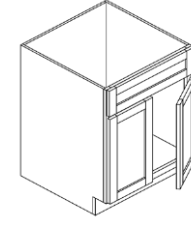
	VSB24	24 x 34.5 x 21	A1, A2, A3, A5, A6, A7, A8, A10, A11
	VSB27	27 x 34.5 x 21	A1, A2, A3, A5, A6, A11
	VSB30	30 x 34.5 x 21	A1, A2, A3, A5, A6, A7, A8, A10, A11
	VSB36	36 x 34.5 x 21	A1, A2, A3, A5, A6, A7, A8, A10, A11
	1 Dummy Drawer, 2 Doors, No Shelf Note: Back Panel Not Cut for Plumbing		

## VANITY SINK BASE - COMBO - DRAWERS ON THE RIGHT

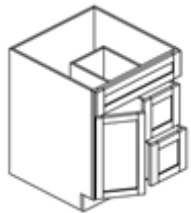
	VSD30DR	30 x 34.5 x 21	A1, A2, A3, A5, A6, A7, A8, A10, A11
	1 Dummy Drawer, 1 Door on the Left, 2 Sets of Glides, No Shelf, 2 Drawers: 12" W Note: Back Panel Not Cut for Plumbing		

## VANITY SINK BASE - COMBO - DRAWERS ON THE LEFT

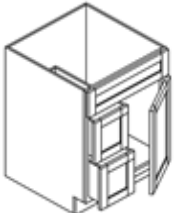
	VSD30DL	30 x 34.5 x 21	A1, A2, A3, A5, A6, A7, A8, A10, A11
	1 Dummy Drawer, 1 Door on the Right, 2 Sets of Glides, No Shelf, 2 Drawers: 12" W Note: Back Panel Not Cut for Plumbing		

## VANITY SINK BASE COMBO - DRAWERS ON THE RIGHT

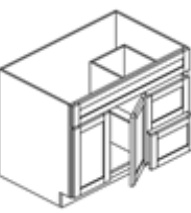
	VSD36DR	36 x 34.5 x 21	A1, A2, A3, A5, A6, A7, A8, A10, A11
	1 Dummy Drawer, 2 Doors on the Left, 2 Sets of Glides, No Shelf, Drawers: 12" W Note: Back Panel Not Cut for Plumbing		

Note: Specifications are subject to change without notice. Our style and product availability may vary slightly from those shown in this catalog.

# VANITY CABINETS

	ITEM CODE	W"x H"x D"	AVAILABLE STYLES
--	-----------	------------	------------------

## VANITY SINK BASE COMBO – DRAWERS ON THE LEFT

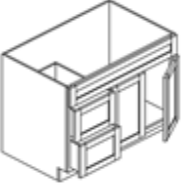
	VSD36L	36 x 34.5 x 21	A1, A2, A3, A5, A6, A7, A8, A10, A11
	<p>1 Dummy Drawer, 2 Doors on the <b>Right</b>, 2 Sets of Glides, No Shelf, 2 Drawers: 12" W  <b>Note: Back Panel Not Cut for Plumbing</b></p>		

## VANITY SINGLE SINK COMBO - SINK IN THE MIDDLE

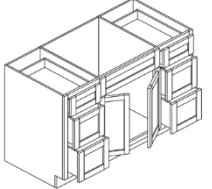
	VDD48	48 x 34.5 x 21	A1, A2, A3, A5, A6, A7, A8, A10, A11
	VDD60	60 x 34.5 x 21	A1, A2, A3, A5, A6, A7, A8, A10, A11
<p>1 Dummy Drawer, 2 Doors, 6 Sets of Glides, 6 Drawers: 12" W  <b>Note: Back Panel Not Cut for Plumbing</b></p>			

## VANITY DOUBLE SINK COMBO - DRAWER IN THE MIDDLE

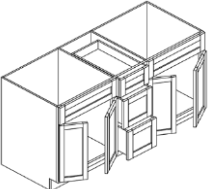
	VCD60	60 x 34.5 x 21	A1, A2, A3, A5, A6, A7, A8, A10, A11
	<p>2 Dummy Drawers, 4 Doors, 3 Sets Of Glides, 3 Drawers: 12" W  <b>Note: Back Panel Not Cut for Plumbing</b></p>		

## VANITY COUNTERTOP CABINET

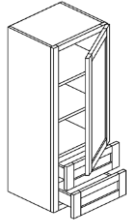
	VCC12*4 4 1/2	12 x 44.5 x 12	A5, A6, A7, A8, A10, A11
	DV1245	12 x 44.5 x 12	A1, A2, A3
<p>12" Deep, 1 Door: 29 1/2" H, 2 Drawers: 7" H, 2 Shelves, 2 Sets of Glides</p>			

# MOLDING & DECOR

	ITEM CODE	W"x H"x D"	AVAILABLE STYLES
--	-----------	------------	------------------

## KNEE DRAWER

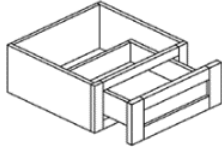
	KDD24	24 x 8.5 x 21	A1, A2, A3, A5, A6, A7, A8, A10, A11
	KDD30	30 x 8.5 x 21	A1, A2, A3, A5, A6, A7, A8, A10, A11
<p><b>A1-A3 4" tall</b>  <b>A5-A11 8 1/2" tall</b></p>			

## BASE END DUMMY DOOR

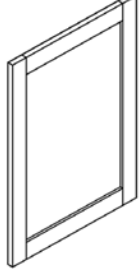
	BDD24	24 x 29.5 x 3/4	A1, A2, A3, A5, A6, A7, A8, A10, A11
	<p>3/4" Thick, 29 1/4" Height</p>		

## TALL DECORATIVE DOOR

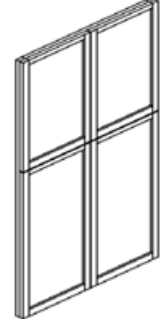
	BDD8427	26 3/4 x 78 3/4 x 3/4	A5, A6, A7, A8, A10, A11
	BDD9027	26 3/4 x 84 3/4 x 3/4	A5, A6, A7, A8, A10, A11
	BDD9627	26 3/4 x 90 3/4 x 3/4	A5, A6, A7, A8, A10, A11
<p>1 Set: 4 Doors, 3/4" Thick, For Pantry/Oven/Ref. Side Panel</p>			

**Note: Specifications are subject to change without notice. Our style and product availability may vary slightly from those shown in this catalog.**

# MOLDING & DECOR

	ITEM CODE	W"x H"x D"	AVAILABLE STYLES		ITEM CODE	W"x H"x D"	AVAILABLE STYLES
--	-----------	------------	------------------	--	-----------	------------	------------------

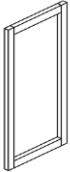
WALL DUMMY DOOR			
	W1230F	11 3/4 x 29.5 x 3/4	A1, A2, A3, A5, A6, A7, A8, A10, A11
	3/4" Thick, Predrilled Hinge Holes, Alternate Doors for Wall Cabinet		

WALL DUMMY DOOR			
	W1236F	11 3/4 x 35.5 x 3/4	A1, A2, A3, A5, A6, A7, A8, A10, A11
	3/4" Thick, Predrilled Hinge Holes, Alternate Doors for Wall Cabinet		

WALL DUMMY DOOR			
	W1242F	11 3/4 x 41.5 x 3/4	A1, A2, A3, A5, A6, A7, A8, A10, A11
	3/4" Thick, Predrilled Hinge Holes, Alternate Doors for Wall Cabinet		

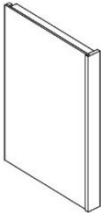
DISHWASHER PANEL WITH RETURN			
	DWR	1 9/16 x 34.5 x 24	A5, A6, A7, A8, A10, A11
	DWR3	3 x 34.5 x 24	A1, A2, A3
	Return Filler For A5-A11: 1 9/16" W, Panel: 23 1/4" Wide, 5/8" Thick <b>Note: Toe Kick Not Included</b>		

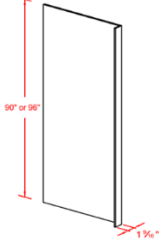
REFRIGERATOR PANEL WITH RETURN			
	RRP9627	27 x 96 x 3	A1, A2, A3
	RRP9627	27 x 96 x 1 1/2	A5, A6, A7, A8, A10, A11
A1-A3 Return Filler: 3", Panel: 26 1/4" Wide, 5/8" Thick A5-A11 Return Filler: 1 9/16", Panel: 26 1/4" Wide 5/8" Thick			

BASE SKIN PANEL			
	BP3696	36 x 96 x 1/4	A1, A2, A3, A5, A6, A7, A8, A10, A11
	Length: 96", Width: 36", Thickness: 1/4"		

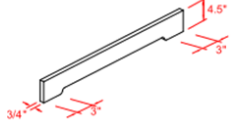
ARCHED VALANCE - PLAIN 4 1/2" H			
	VAL30-4 1/2	30 x 4.5 x 3/4	A5, A6, A7, A8, A10, A11
	VAL36-4 1/2	36 x 4.5 x 3/4	A5, A6, A7, A8, A10, A11
	VAL42-4 1/2	42 x 4.5 x 3/4	A5, A6, A7, A8, A10, A11
	VAL48-4 1/2	48 x 4.5 x 3/4	A5, A6, A7, A8, A10, A11
	VAL54-4 1/2	54 x 4.5 x 3/4	A5, A6, A7, A8, A10, A11
	VAL60-4 1/2	60 x 4.5 x 3/4	A5, A6, A7, A8, A10, A11
3/4" Thick, 4 1/2" Height			

PRODUCT SPECS

Note: Specifications are subject to change without notice. Our style and product availability may vary slightly from those shown in this catalog.

	ITEM CODE	W"x H"x D"	AVAILABLE STYLES
--	-----------	------------	------------------

ARCHED VALANCE - PLAIN 8" H			
	VAL36-8	36 x 8 x 3/4	A5, A6, A7, A8, A10, A11
	VAL42-8	42 x 8 x 3/4	A5, A6, A7, A8, A10, A11
	VAL48-8	48 x 8 x 3/4	A5, A6, A7, A8, A10, A11
	VAL54-8	54 x 8 x 3/4	A5, A6, A7, A8, A10, A11
	VAL60-8	60 x 8 x 3/4	A5, A6, A7, A8, A10, A11
3/4" Thick, 8" Height			

ARCHED VALANCE - RAISER PANEL 15" H			
	VAL36-15	36 x 15 x 3/4	A5, A6, A7, A8, A10, A11
	VAL42-15	42 x 15 x 3/4	A5, A6, A7, A8, A10, A11
	VAL48-15	48 x 15 x 3/4	A5, A6, A7, A8, A10, A11
	VAL54-15	54 x 15 x 3/4	A5, A6, A7, A8, A10, A11
	VAL60-15	60 x 15 x 3/4	A5, A6, A7, A8, A10, A11
3/4" Thick, 15" Height			

POST - FULL TRADITIONAL TURNED POST			
	PS3 X 34 1/2	3 x 34.5 x 3	A1, A2, A3, A5, A6, A7, A8, A10, A11
	3" Wide, 3" Deep, 34 1/2" H		

POST - SQUARE POST			
	SPS3 34 1/2	3 x 34.5 x 3	A5, A6, A7, A8, A10, A11
	3" Wide, 3" Deep, 34 1/2" H		

	ITEM CODE	W"x H"x D"	AVAILABLE STYLES
--	-----------	------------	------------------

LEAF CORBEL			
	SLC4 1/2 X 10	4.5 x 10.5 x 5	A1, A2, A3, A6
	All Wood, Hand Curved		

MISSION CORBEL			
	SC4 1/2 x 10	4.5 x 10.5 x 5	A5, A6, A7, A8, A10, A11
	All Wood, Hand Curved		

BASE FILLER - TOE KICK ATTACHED			
	BF3	3 x 34.5 x 3/4	A1, A2, A3, A5, A6, A7, A8, A10, A11
	BF6	6 x 34.5 x 3/4	A1, A2, A3, A5, A6, A7, A8, A10, A11
All Wood Filler, Toe Kick Attached, Matching Finish			

WALL FILLER			
	WF330	3 x 30 x 3/4	A1, A2, A3, A5, A6, A7, A8, A10, A11
	WF336	3 x 36 x 3/4	A1, A2, A3, A5, A6, A7, A8, A10, A11
	WF342	3 x 42 x 3/4	A1, A2, A3, A5, A6, A7, A8, A10, A11
	WF630	6 x 30 x 3/4	A1, A2, A3, A5, A6, A7, A8, A10, A11
	WF636	6 x 36 x 3/4	A1, A2, A3, A5, A6, A7, A8, A10, A11
	WF642	6 x 42 x 3/4	A1, A2, A3, A5, A6, A7, A8, A10, A11
All Wood Filler, Matching Finish			

Note: Specifications are subject to change without notice. Our style and product availability may vary slightly from those shown in this catalog.

# MOLDING & DECOR

ITEM CODE	W"x H"x D"	AVAILABLE STYLES
-----------	------------	------------------

TALL FILLER			
	WF396	3 x 96 x 3/4	A1, A2, A3, A5, A6, A7, A8, A10, A11
	WF696	6 x 96 x 3/4	A1, A2, A3, A5, A6, A7, A8, A10, A11
<p>All Wood Filler, Matching Finish</p> <p><b>Note: WF396 Comes With Dado On The Back</b></p>			

FACE FRAME FILLER			
	FF8-1 9/16	96 x 1 9/16	A5, A6, A7, A8, A10, A11
	<p>Length: 96", Width: 1 9/16", Thickness: 3/4"</p> <p><b>Note: Dado On The Back</b></p>		

FLUTED FILLER - DECORATIVE FILLER			
	RWF396	96 x 3	A1, A2, A3, A6, A8, A11
	<p>Length: 96", Width: 3", Thickness: 3/4"</p> <p><b>Note: Dado On The Back</b></p>		

CLASSIC CROWN MOLDING - NO BASE - SMALL			
	CM8 - 2 1/8	96 x 2 1/8	A5, A6, A7, A8, A10, A11
	<p>Length: 96", Height: 2 1/8", Depth: 1 3/4", Thickness: 3/4"</p>		

ITEM CODE	W"x H"x D"	AVAILABLE STYLES
-----------	------------	------------------

CLASSIC CROWN MOLDING - NO BASE - LARGE			
	CM8 - 3 3/4	96 x 3 3/4	A5, A6, A7, A8, A10, A11
	<p>No Base, Length: 96", Height: 3 3/4", Depth: 3 7/8", Thickness: 3/4"</p>		

CLASSIC CROWN MOLDING WITH BASE - SMALL			
	CMB8 - 2 1/8	96 x 2 1/8	A5, A6, A7, A8, A10, A11
	<p>Length: 96", Height: 2 1/8", Depth: 1 3/4", Thickness: 3/4"</p>		

CLASSIC CROWN MOLDING - WITH BASE - LARGE			
	CMB8 - 3 3/4	96 x 3 3/4	A5, A6, A7, A8, A10, A11
	<p>Length: 96", Height: 3 3/4", Depth: 3 7/8", Thickness: 3/4"</p>		

SHAKER COVE MOLDING - NO BASE - SMALL			
	ST8 - 2 1/4	96 x 2 1/4	A5, A6, A7, A8, A10, A11
	ST8 - 3 1/4	96 x 2 1/4	A1, A2, A3
<p>Length: 96", Height: 2 1/4", Depth: 2 1/8", Thickness: 3/4"</p>			

PRODUCT SPECS

**Note:** Specifications are subject to change without notice. Our style and product availability may vary slightly from those shown in this catalog.

# MOLDING & DECOR

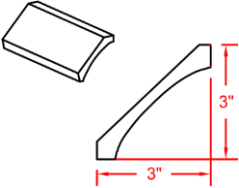
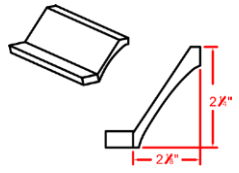
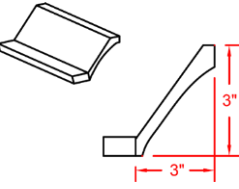
	ITEM CODE	W"x H"x D"	AVAILABLE STYLES
<b>SHAKER COVE MOLDING - NO BASE - LARGE</b>			
	ST8 - 3	96 x 3	A5, A6, A7, A8, A10, A11
	ST8 - 5 1/4	96 x 4 1/4	A1, A2, A3
Length: 96", Height: 3", Depth: 3", Thickness: 3/4"			
<b>SHAKER COVE MOLDING - WITH BASE - SMALL</b>			
	STB8 - 2 1/4	96 x 2 1/4	A5, A6, A7, A8, A10, A11
	AST8 - 3 1/4	96 x 3 1/4	A1, A2, A3
Length: 96", Height: 2 1/4", Depth: 2 1/8", Thickness: 3/4"			
<b>SHAKER COVE MOLDING - WITH BASE - LARGE</b>			
	STB8 - 3	96 x 3	A5, A6, A7, A8, A10, A11
	AST8 - 5 1/4	96 x 4 1/4	A1, A2, A3
Length: 96", Height: 3", Depth: 3", Thickness: 3/4"			

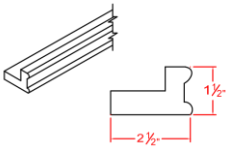
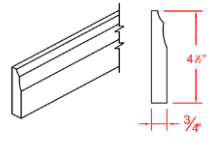
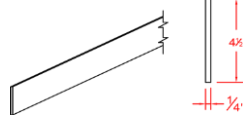
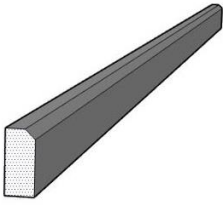
	ITEM CODE	W"x H"x D"	AVAILABLE STYLES
<b>LIGHT RAIL MOLDING</b>			
	LRM8 - 1 1/2	96 x 1 1/2	A1, A2, A3, A5, A6, A7, A8, A10, A11
	Length: 96", Height: 1 1/2", Depth: 2 1/2", Thickness: 3/4"		
<b>BASE MOLDING</b>			
	BM8 - 4 1/2	96 x 4 1/2	A1, A2, A3, A5, A6, A7, A8, A10, A11
	Length: 96", Wide: 4 1/2", Thickness: 3/4"		
<b>TOE KICK / TOE PLATE</b>			
	TK8	96 x 4 1/2	A1, A2, A3, A5, A6, A7, A8, A10, A11
	Length: 96", Wide: 4 1/2", Thickness: 1/4"		
<b>BEVEL MOLDING</b>			
	CTM8	96 x 3/4	A2, A3, A8, A10, A11
	Length: 96", Wide: 1 1/2" Thickness: 3/4"		

Note: Specifications are subject to change without notice. Our style and product availability may vary slightly from those shown in this catalog.

# MOLDING & DECOR

ITEM CODE	W"x H"x D"	AVAILABLE STYLES
-----------	------------	------------------

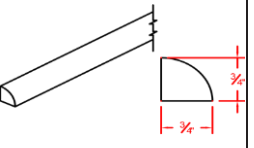
QUARTER ROUND MOLDING		
	QRM8	96 x 3/4 x 3/4
A1, A2, A3, A5, A6, A7, A8, A10, A11		
Length: 96", Wide: 3/4", Thickness: 3/4"		

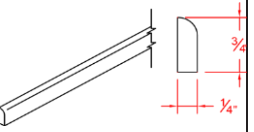
SCRIBE MOLDING / TRIM MOLDING		
	SM8	96 x 1/4 x 3/4
A1, A2, A3, A5, A6, A7, A8, A10, A11		
Length: 96", Wide: 3/4", Thickness: 1/4"		

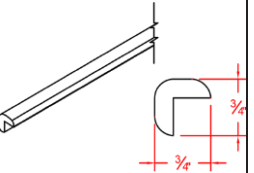
OUTSIDE CORNER MOLDING		
	OCM8	96 x 3/4 x 3/4
A1, A2, A3, A5, A6, A7, A8, A10, A11		
Length: 96", Wide: 3/4", Thickness: 1/4"		

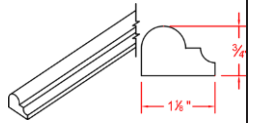
CHAIR RAIL MOLDING		
	CRM8	96 x 1 1/8 x 3/4
A1, A2, A3, A5, A6, A7, A8, A10, A11		
Length: 96", Wide: 1-1/8", Thickness: 3/4"		

ITEM CODE	W"x H"x D"	AVAILABLE STYLES
-----------	------------	------------------

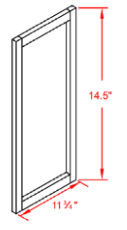
SAMPLE DOOR		
	SAMPLE DOOR	11 3/4x14.5x 3/4
A1, A2, A3, A5, A6, A7, A8, A10, A11		
Width: 11 3/4", Height: 14 1/2"		

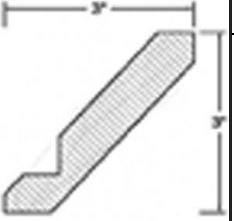
SLANTED MOLDING		
	ACM8	96" x 3"
A2, A3, A8, A10, A11		
Length: 96", Wide: 3", Thickness: 3"		

PRODUCT SPECS

Note: Specifications are subject to change without notice. Our style and product availability may vary slightly from those shown in this catalog.

# KITCHEN STANDARD SIZE AND ITEM CODE

W331227  
W331527  
W331827  
W332127  
W332427

W361227  
W361527  
W361827  
W362127  
W362427

W0930  
W0936  
W0942

W1230 W1830 W3012  
W1236 W1836 W3015  
W1242 W1842 W3018  
W3021

W1530 W2130 W3024  
W1536 W2136 W3312  
W1542 W2142 W3315

W3318  
W3321  
W3324

W2430 W3330  
W2436 W3336  
W2442 W3342

W2730 W3630  
W2736 W3636  
W2742 W3642

W3030 W4230  
W3036 W4236  
W3042 W4242

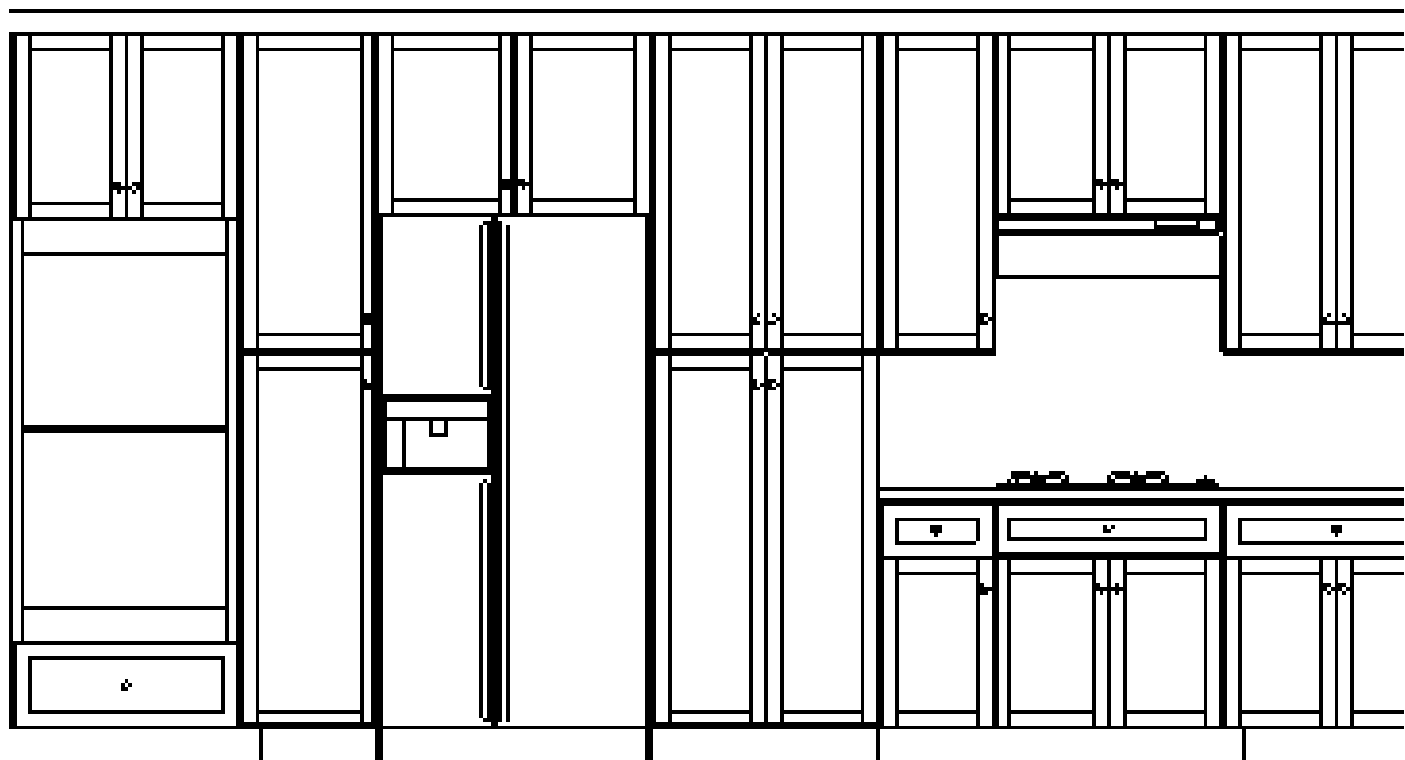

DOC338427  
DOC339027  
DOC339627

PC188427  
PC189027  
PC189627

PC248427  
PC249027  
PC249627

PC308427  
PC309027  
PC309627

B09  
B12  
B15  
B18  
B21

SB30  
SB33  
SB36

B24  
B27  
B30



WM273012  
WM273612  
WM274212

WMD1530  
WMD1536  
WMD1542

WMD1830  
WMD1836  
WMD1842

W3612  
W3615

W3618  
W3621  
W3624

30WR 30GR  
36WR 36GR

WMD2430  
WMD2436  
WMD2442

WMD2730  
WMD2736  
WMD2742

WMD3030  
WMD3036  
WMD3042

WES0930  
WES0936  
WES0942

WEC0930  
WEC0936  
WEC0942

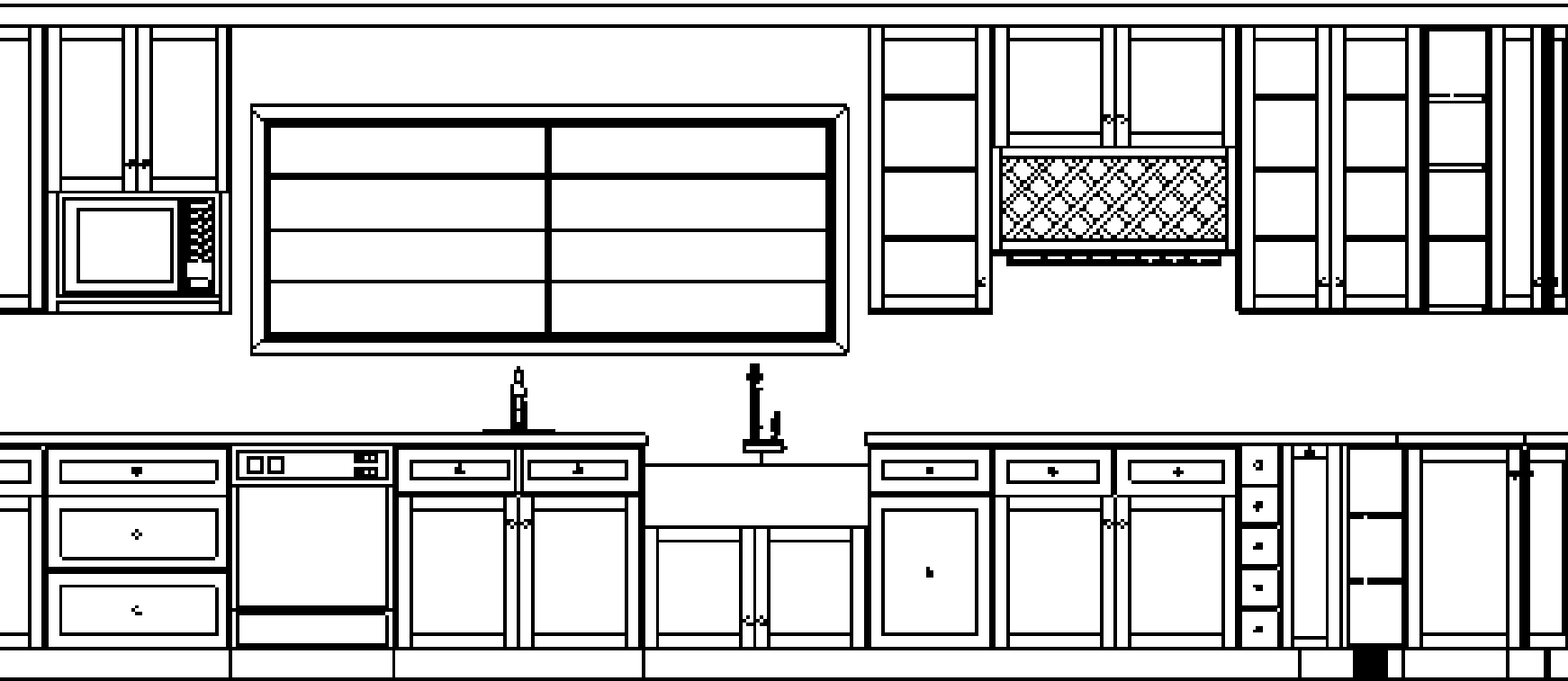

DB12-3  
DB15-3  
DB18-3  
DB21-3  
DB24-3  
DB27-3  
DB30-3  
DB33-3  
DB36-3

SB33  
SB36  
SB42

APSB36

BWBK18-2

B33  
B36  
B42

BSD06

BSR09

BES09

BEC24

# VANITY CONCEPTS



45"  
VBD12-3 + VB21 + VBD12-3



48"  
VDD48



54"  
VBD15-3 + VSB24 + VB15



60"  
VDD60



60"  
VCD60

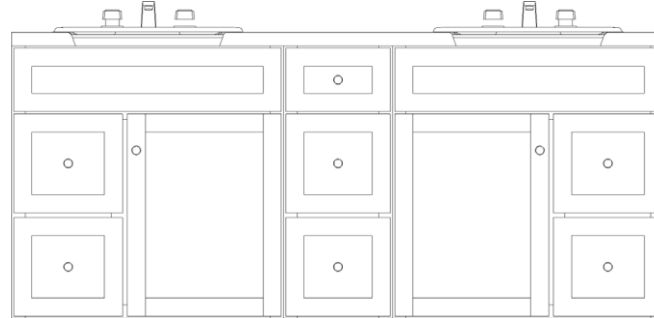

72"  
VSD30DL + VBD12-3 + VSD30DR

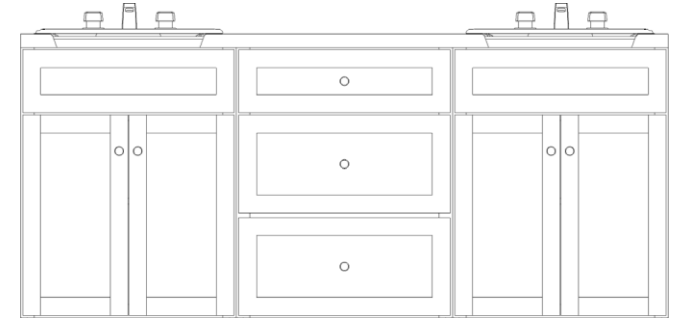

72"  
VSB24 + VBD24 + VSB24

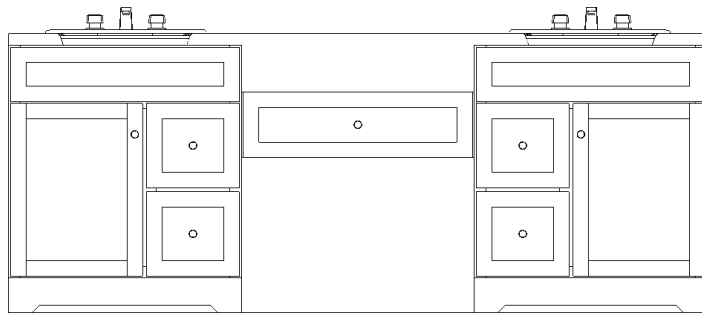

90"  
VSD30DR + KDD30 + VSD30DL

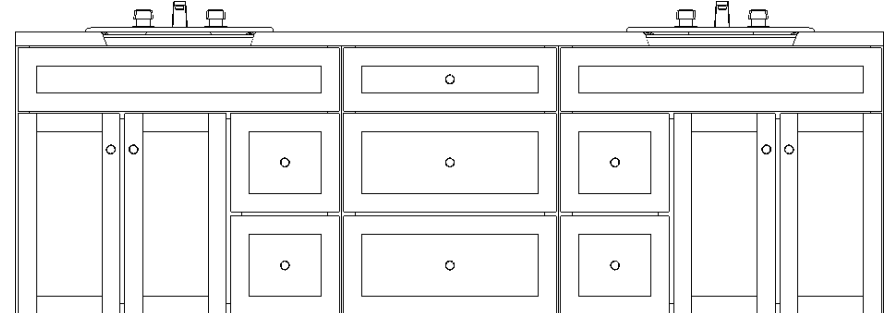

96"  
VSD36DR + VBD24-3 + VSD36DL

VCC12\*44 1/2

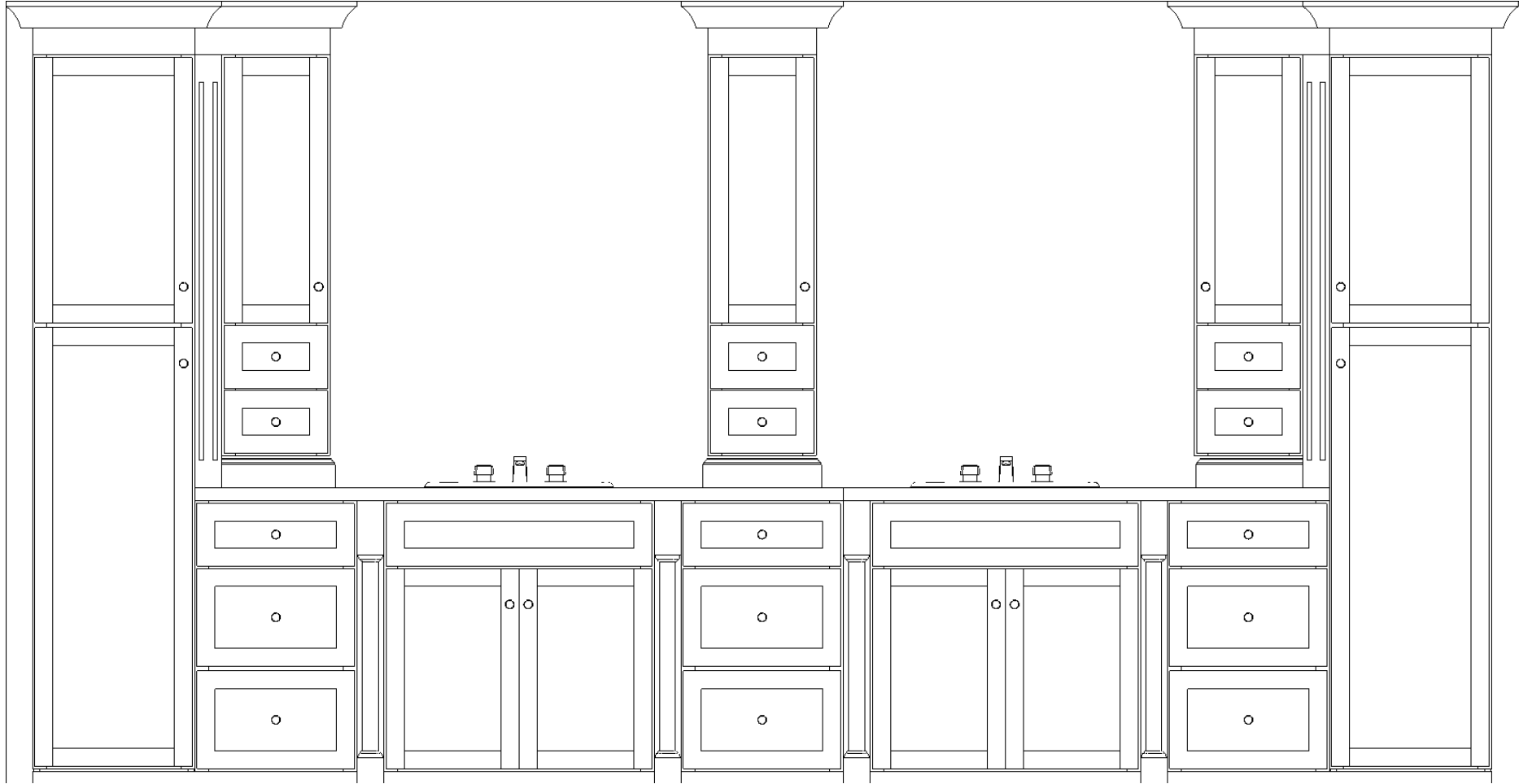

PC188427

VBD18D-3

VSB30

VBD18-3

VSB30

VBD18-3

PC188427

162"

# SINKS



**Model: SS SM3118**

**Single Bowl Stainless Steel Kitchen Sink**

**Product Features:**

Style: Under Mount

Steel Thickness: 18 Gauge

Exterior Dimensions: 31 5/16" x 17 7/8" x 9"

Interior Dimensions: 29 1/8" x 15 3/4" x 8 7/8"



**Model: SS AP3322D-A**

**Double Bowl Stainless Steel Apron Sink 50/50**

**Product Features:**

Style: Under Mount

Steel Thickness: 18 Gauge

Exterior Dimensions: 33" x 22 3/8" x 9"

Interior Dimensions: 30 3/4" x 17 7/8" x 9 7/8"



**Model: SS SM502**

**Double Bowl Stainless Steel Kitchen Sink 50/50**

**Product Features:**

Style: Under Mount

Steel Thickness: 18 Gauge

Exterior Dimensions: 31 3/8" x 18" x 8 3/4"

Interior Dimensions: 29 1/4" x 15 7/8" x 8 5/8"



**Model: Sink 208**

**Oval Shape Ceramic Bathroom Sink**

**Product Features:**

Style: Under Mount

Color: White

Exterior Dimensions: 18 3/4" x 15 1/2" x 7 3/4"

Interior Dimensions: 16 1/2" x 13 1/2" x 5 1/2"



**Model: SS SM503R**

**Double Bowl Stainless Steel Kitchen Sink 60/40**

**Product Features:**

Style: Under Mount

Steel Thickness: 18 Gauge

Exterior Dimensions: 32" x 20 5/8" x 9"

Interior Dimensions: 29 7/8" x 18 1/2" x 8 7/8"



**Model: Sink 2013**

**Rectangular Ceramic Bathroom Sink**

**Product Features:**

Style: Under Mount

Color: White

Exterior Dimensions: 20 1/4" x 15" x 7 3/4"

Interior Dimensions: 18" x 12 3/4" x 5 1/2"



**Model: SS AP3322C-33**

**Rectangular Ceramic Bathroom Sink**

**Product Features:**

Style: Under Mount

Steel Thickness: 18 Gauge

Exterior Dimensions: 33" x 22 1/4" x 9"

Interior Dimensions: 30 3/4" x 17 7/8" x 9 7/8"



**Model : SS SM503L**

**Double Bowl Stainless Steel Kitchen Sink 40/60**

**Product Features:**

Style: Under Mount

Steel Thickness: 18 Gauge

Exterior Dimensions: 32" x 20 5/8" x 9"

Interior Dimensions: 8 7/8" x 29 7/8"





# LIMITED WARRANTY FOR ONE YEAR



## Warranty.

A1 Cabinet and Granite, also known as A1, warrants that all cabinets sold by A1 are free from defects in material and workmanship under normal use for a period of one year (1) limited warranty from the date of purchase. This warranty is only applicable to products used in residential applications and is not transferable to subsequent owners. This warranty shall become void if the cabinets are in any way modified, improperly assembled, installed or damaged prior to or during the installation. Furthermore, this warranty will not apply to cabinets damaged by misuse, neglect, abuse, exposure to moisture, exposure to extreme temperatures or the effects of normal wear and tear.

## Variations and Environmental Exposures Not Covered.

By purchasing the product, the original purchaser acknowledges that natural woods may vary in color, characteristics and exhibit subtle changes as they age. Sunlight, smoke, moisture, household cleaners and other environmental conditions may also affect the color match, or cause the materials to warp, split, or crack over time. These variations are the nature of the material in relation to their environmental exposure and are not covered under this warranty.

## Updated Product Lines.

A1 periodically updates and makes changes to its product line and specifications. If a warranty claim is filed after a A1's product becomes obsolete, A1 reserves the right to alter specifications and material without obligation to make similar changes to products previously manufactured. A1 will replace the part under warranty with a new part of the same style or with a similar style currently offered, but A1 cannot guarantee that the finish of these replacements will exactly match the finish and appearance of the components in the residential application. This is due to the changes that occur during the woods natural aging process, affecting its color and grain.

## Disclaimers.

*THIS WARRANTY IS THE EXCLUSIVE WARRANTY OF A1 Cabinet and Granite AND IS IN LIEU OF AND A1 Cabinet and Granite DISCLAIMS ALL OTHER WARRANTIES, EXPRESSED OR IMPLIED, INCLUDING THE IMPLIED WARRANTIES OF MERCHANTABILITY AND FITNESS FOR A PARTICULAR PURPOSE.*

## Non-Transferability of Warranty.

A1's warranty is not transferable to end-users, including consumers and homeowners who purchase A1 products through the original purchaser. Any and all end-user warranty claims must be handled through and by the original purchaser, which may independently provide warranties to the end-user. Where the original purchaser, through its independent warranty with an end-user, is liable for a claim that would otherwise have been covered by A1's warranty to the original purchaser but for its non-transferability.

## Submitting a Claim.

To obtain replacement(s) under this limited warranty, the original purchaser must contact the A1's office. A payment receipt or paid invoice as proof of purchase is required to obtain benefits from this warranty, dated no earlier than one year (1) from the date of warranty claim and (2) if the claim is from an end user, first contact our office, who will arrange for inspection of the cabinet. A copy of the end-user's the original purchaser payment receipt is required, dated no earlier than one year (1) from the date of warranty claim.

# **A1** CABINET & GRANITE, LLC

1401 W. Bond Cir Suite#8 Lincoln, NE 68521

[a1cabinetngranite@gmail.com](mailto:a1cabinetngranite@gmail.com)

P:402-474-0848

F:402-904-5258

A1cng.com

Monday-Saturday 8:30 am to 5:30 pm

*The photography and color samples shown in this catalog have been reproduced as accurately as printing technologies permit and are for representation only.  
To ensure the highest satisfaction, we strongly recommend you view an actual product sample prior to ordering cabinetry.*